



# Electrak<sup>®</sup>

E12, E15, E20 Tractor

GEZ-5338A



## ROTARY MOWER

AA42

- Front mounted for trimming under and around bushes, trees, etc. Cuts the grass before the tractor rolls over it, greater visibility allows more cutting on every pass
- Mowers are available with either side discharge (best for long grass without grass pickup) or rear discharge — between wheels under tractor (safest and facilitates grass or leaf pickup with sweeper or vacuum)
- 3 blades and 3 motors provide large 42" cutting width
- Mower flips up for simple cleaning and easy blade changing or sharpening
- Blades stop in less than 3 seconds when operator leaves seat, switches PTO off, or turns off key



## DUMP CART

AF12

- Large 12-cubic foot 1000-lb capacity (4' x 3' x 1')
- All steel body with full-length bottom reinforcing channels
- Removable rear tail gate slides between reinforced channels
- Stake pockets for adding side extensions
- Spring-loaded latch for dumping. Locks itself



## LAWN SWEEPER

AS31

- Electric-motor kit (KS31) provides superior sweeping at a constant speed
- 31" sweeper brush, sweeps an area wider than the discharge width of the 42" ELEC-TRAK rear discharge mower
- Convenient rear dump and brush height adjustment from the driver's seat
- Light duty dethatching can be done with powered sweeper

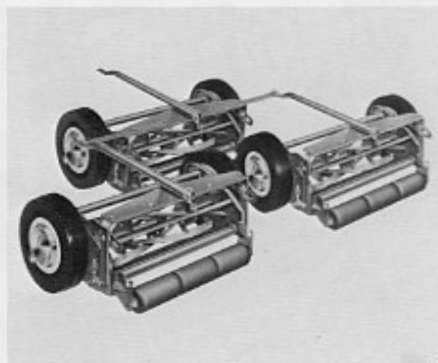

## GANG MOWER

AR57

- 3-gang reel mower cuts 57" width
- Easily adjustable from 1/2" to 2-1/2" cutting height of 5-gang reel
- 6 tempered blades and heat-treated bedknife
- Universal hitches allow attachment of up to 5-gang reel



**Elec-Trak**

## FOR WINTER



**42" SNOW THROWER AD42**

- Instant on. Safety interlock with tractor seat switch
- High torque, single-stage direct chain drive auger works independently of tractor speed
- Discharge chute rotates 270° from tractor seat
- Adjustable skid shoes
- Raise or lower electrically with standard tractor lift
- Requires AP85 weight box



**48" DOZER BLADE AB48**

- Large 48" blade width
- Angle adjustment controlled from driver's seat
- Height of blade controlled by standard electric tractor lift
- Replaceable wear blade is adjustable to vary the blade attack
- Blade trip springs protect against damage
- High traction/torque of ELEC-TRAK tractor makes dozing heavy loads easy



**SNOW CAB AG55**

- Simple and rugged steel construction for strength and ease of assembly
- Large safety-glass windshield with electric windshield wiper
- Snap-in nylon reinforced curtains with vinyl windows for winter
- Easy entry into cab with large zippered doorway
- A convenient pocket flap opening allows easy access to operate snow thrower or dozer blade

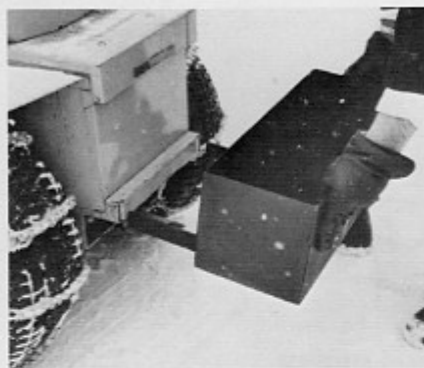

**WEIGHT/TOOL BOX AP85**

- Required for use with Snow Thrower for best traction (Included in Snow Thrower Package)
- Weight box locks into rear stabbers
- Will hold 200 lbs of ballast (5 standard 4" concrete blocks at 40 lbs) or carry tools, accessories

### CHAINS

- Chains for 8:50 tires, 2 links AP65
- Chains for 9:50 tires, 4 links AP66
- Chains for 9:50 tires, 2 links AP68



**48" V-PLOW BV48**

- High-speed sidewalk plowing
- Clears a 48" path through snow
- 18" high, heavy-duty all-steel blades
- Replaceable steel wear bar on each blade
- Raise or lower electrically with standard tractor lift
- With three gauge shoes for maintaining height adjustment



**TRACTOR COVER AP80  
MOWER COVER AP81**

- Made of strong, durable, black, vinyl-coated nylon
- Designed for temperatures to -40°F
- Has air vents for good air circulation
- Easily mounted on tractor or mower with an elastic shock cord hem

## FOR YARD GROOMING



**POWER HANDLE** TM3

- 36-volt power unit
- Plugs into tractor accessory outlet
- Takes drill, grass trimmer, and hedge trimmer heads

### DRILL

- TH20 drill head – takes up to 1/4" drills
- TH30 drill head – takes up to 3/8" drills

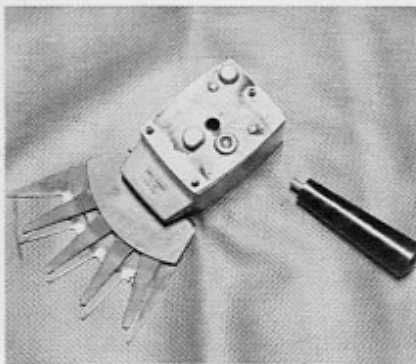

**GRASS TRIMMER HEAD** TH80

- Ideal for cutting around trees, rocks, along stone walls, under fences
- Has built-in clutch which will slip to prevent damage to the mechanism should hard objects get into blades
- Fits GE TM3 power unit.

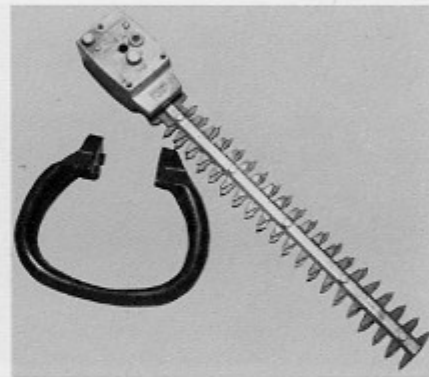

**HEDGE TRIMMER HEAD** TH70

- Double-edge 15" steel blades with reciprocating motion
- Helper handle makes it easy to use in horizontal or vertical positions
- Fits standard GE TM3 power unit



**WEEDER/CULTIVATOR** HC05

- Makes weeding, cultivating, or digging a garden easy
- Tills an area 5" wide, can dig down to 6" depth
- Easy to operate with trigger switch and only weighs 9 lbs.
- A long handle lets you stand up and keep clean
- Requires extension cord HT25

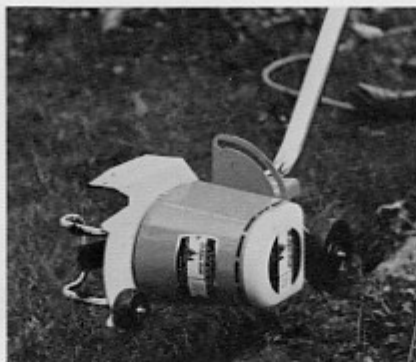

**LAWN EDGER/TRIMMER** HE06

- Use for edging or lawn trimmer
- Extra front wheels provides smooth edging
- A rear guard helps protect the operator
- Has a built-in anti-scrape guard for trimming
- A light 8½ lbs make long usage easy
- Requires extension cord HT25



**ELECTRIC CHAIN SAW** HS13

- Light weight
- Fast, high-speed cuts with Oregon Chain
- Instant on and off with trigger-type switch
- 13" bar will double cut up to 26" logs
- Plunger-type oiler forces oil into chain while cutting
- Complete with 20-foot cord and plug.



**Elec-Trak**

## FOR GARDENING



### TILLER (VV-100 Brinly)      TILLER MOUNTING BRACKET (VV-101 Brinly)

- Tills 30" width
- Tills up to 20,000 sq ft at four-inch depth on one charge of tractor
- Tiller can be center mounted or offset to either side
- Mounts to axle with tiller mounting bracket
- Can be adjusted for two tilling angles
- Used with electric rear lift (AP59)

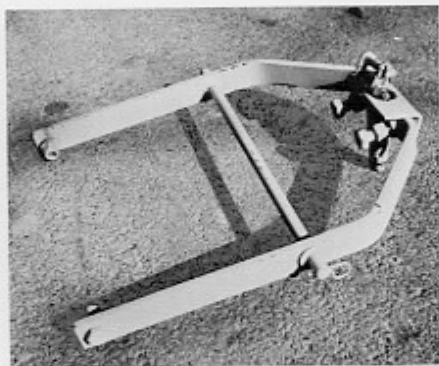

### SLEEVE HITCH      AP50

- Takes Brinly-Hardy implements built to industry standard for sleeve hitch implements
- Easy to attach with two bolts
- Can be used with electric or manual rear lift (AP59, AP58)

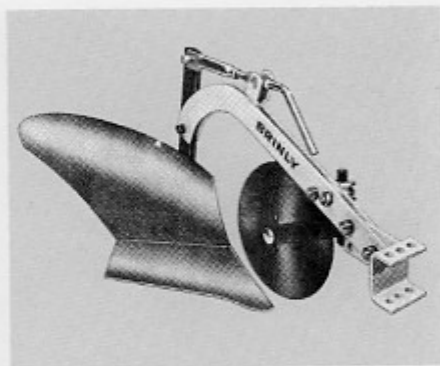

### MOLDBOARD PLOW (PP510 - Brinly)

- 10" moldboard plow with adjustable hitch clevis for different plowing conditions
- Has an 11" rolling coulter that will swing out for trash clearance
- Secures to tractor with sleeve hitch (AP50)
- Quiet, high-traction ELEC-TRAK tractor makes plowing a pleasure
- Easy disengagement or transport with rear lift (AP58 or AP59)

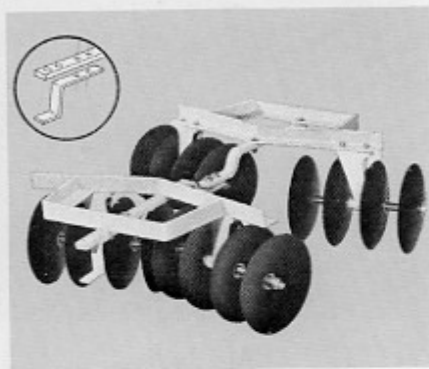

### DISK HARROW (DD500 - Brinly)

- Has eight 11" diameter steel disk blades for cutting width of 29 to 39 inches
- Individual disks have a positive angling adjustment of 10, 15, and 20 degrees
- Angle weight box holds standard 16" concrete block
- Attaches to either sleeve hitch
- Easy disengagement or transport with rear lift (AP58 or AP59)

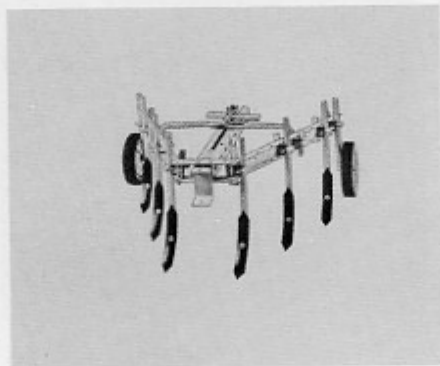

### ROW CROP CULTIVATOR (CC500 - Brinly)

- A versatile unit for cultivating a wide range of crops
- Adjustable for rows from 6" to 42" wide
- Use for straddle-row, reverse position for between-row cultivation
- Equipped with 7 reversible shovels, gauge wheels, bolt and strap for holding weight block
- Easy disengagement or transport with rear lift (AP58 or AP59)

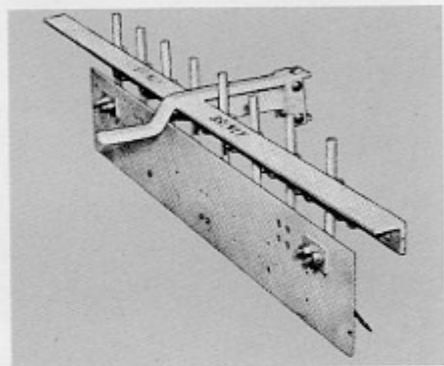

### TOOL BAR (TT100 - Brinly)

- The tool bar, with appropriate accessories, extends the use of your tractor to many operations; including: light grading, scarifying, back-filling, finish grading, seed-bed preparation, hilling, covering, cultivating, disking and packing
- Consists of 5-ft long steel bar welded to heavy-duty hitch, with rear extension for attaching drags, etc.
- Easy disengagement or transport with rear lift (AP58 or AP59)

## FOR HOME, FARM AND BUSINESS



**DC ARC WELDER AP90**

- For farm, home, and general maintenance welding on 1/6" to 1/2" steel
- Portable DC arc welder plugs directly into tractor power supply
- 3-heat ranges; low, medium and high up to 180 amp

**WELDER ACCESSORY KIT AP92**

- Contains approved fiberglass welding helmet, a large safety glass area, leather gloves, and welding rods

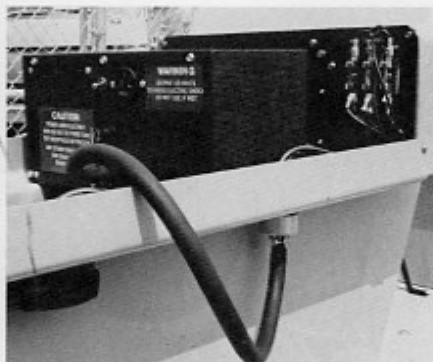

**INVERTER AP60**

- AC inverter provides 117-volt, 60-Hertz power from tractor
- Fully charged battery at 80°F provides 250-watts for 15 hours, 500-watts for 10 hours, or 1000 watts for 5 hours
- Fully charged battery at 32°F provides 250 watts for 15 hours, 500 watts for 10 hours, or 1000 watts for 2½ hours

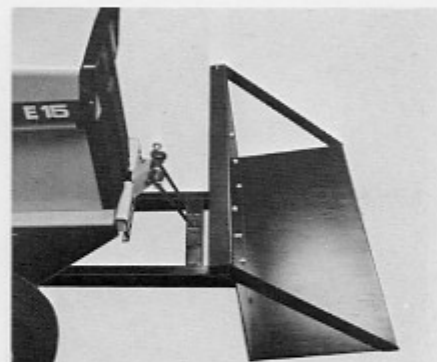

**FRONT PLATFORM LIFT BL36**

- Rests flat on ground and tilts as it lifts to hold objects secure
- Platform mounts on front of tractor with AP56 bracket
- May be raised and lowered with standard electric lift
- Designed for transporting up to 250 lbs —move shrubs, fertilizer, garbage cans, etc.

## FOR CLEAN-UP



**VACUUM AND CART (Turf or Hard Surfaces)**

- Ideal for turf and grounds vacuuming
- Anti-scalp design prevents digging or scraping turf
- 30" nozzle opening adjustable from the tractor seat
- 12 bu bagging capacity with extra large opening for dumping
- Throw-a-way bag liners optional
- Vacuum cart usable by itself as a trailing cart
- Optional 6" hose kit available for hand cleaning

(AVAILABLE AUGUST 1971)



**VACUUM (Hard Surfaces)**

- Quiet, powerful, electrically operated vacuum plugs into and trails behind ELEC-TRAK tractor or operates on a cord in hard-to-get-at areas
- 30" adjustable nozzle opening for large papers or fine sand
- Clean disposal of collected debris with 2.6 bu throw-a-way bags
- Optional 6" hose kit available for hand cleaning
- Optional heads available for indoor or outdoor use

(AVAILABLE AUGUST 1971)

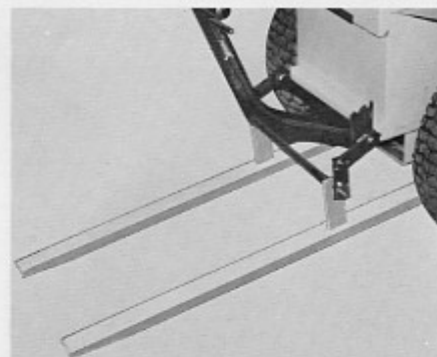

**LIGHT DUTY PALLET HANDLER—REAR OR FRONT MOUNT CP20**

- Easily lifted with standard front lift or manual or electric rear lift
- Lifts and carries loads up to 300 lbs
- Mounts on front (AP56 bracket) or on rear of tractor



**MANUAL REAR LIFT** AP58

- Has 7 to 1 mechanical advantage—lifts sleeve hitch and tools or pallet handler
- Fits easily into rear stabber
- Designed for easy attachment to AP50 sleeve hitch
- Lift can be set at four different height adjustments

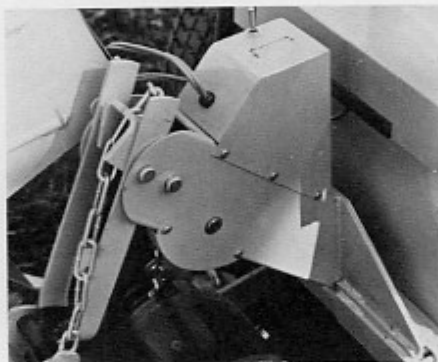

**ELECTRIC REAR LIFT** AP59

- Quickly mounts into rear stabber
- Plugs electrically into its own outlet
- A flick of the switch lifts or lowers attachments
- Can be used with any sleeve hitch attachments or pallet handler

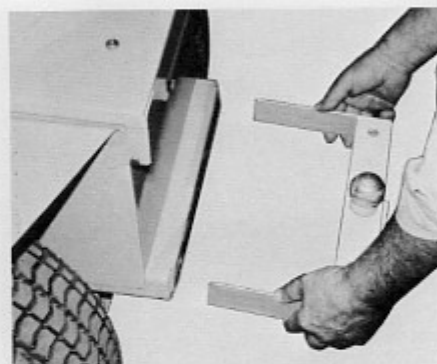

**HITCH ADAPTER** CH10

- A variety of hitches can be attached or easily installed as illustrated by ball hitch above
- Hitches mount securely in rear (stabber) openings

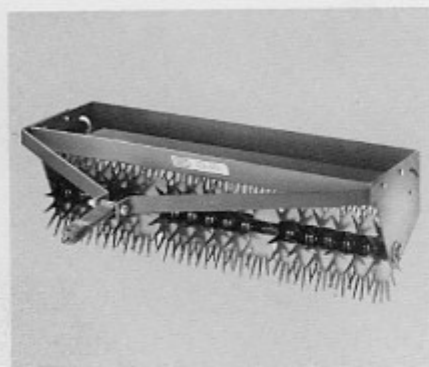

**ROLLER AERATOR/  
CULTIVATOR** BA36

- 36" wide with 18 spikers
- Loosens soil for sun and rain to help grass grow
- Each spiker operates individually to neatly punch holes
- Equipped with oilite bearings and a tray for additional weights
- Quickly attaches to tractor pin hitch



**BROADCAST SPREADER** BS40

- Cover 4 to 8 ft in one swath
- Feathered edge eliminates fertilizing streaks
- Adjustable flow control and instant on-off
- Can be towed or used as a walk-behind
- Large 40 lb — 5 gallon capacity

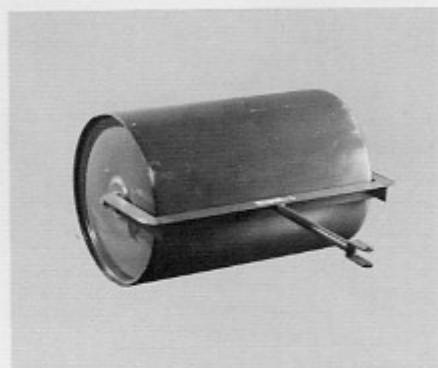

**LAWN ROLLER** BR36

- 36" wide and weight is approx. 600 lbs filled with water
- Rounded edges prevent harm to turf on turns
- Scraper bar automatically cleans the drum, making rolling smoother
- Brass pipe plug is strong and non-rusting



**DOUBLE SEAT** **BD22**

- Converts your tractor to a personnel carrier
- When used in conjunction with Canopy Top and Golf Bag Holder converts tractor to a 2-passenger golf cart



**GOLF BAG HOLDER  
CANOPY TOP** **BG33  
BC11**

- Golf bag holder easily attaches to rear of tractor
- Will hold two golf bags with quick release straps
- Canopy attaches to tractor body
- Covers seats and controls
- Can be used with either standard or double seat

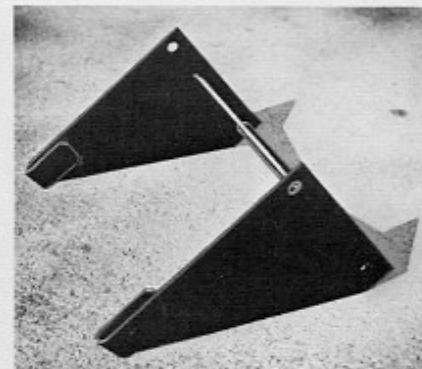

**FRONT IMPLEMENT  
MOUNTING BRACKET** **AP56**

- To be used with dozer blade, V-plow, snow thrower, and front platform lift and pallet handler
- Easily slides into front stabber and locks on with front clevis pins
- For E12, E15, and E20



**ELECTRIC HORN** **AP69**

- 12-volt electric horn
- Easy to operate with large push type horn button
- The kit is complete for hook-up and installation
- Provides easily heard signal to warn bystanders or gain attention



**POWERED ROTARY BROOM**

- 4 ft Rotary broom ideal for clearing debris, gravel, leaves or light snow
- Powered by separate 36-volt electric motor (same as snow thrower—interchangeable)
- Perfect for outdoor skating rink maintenance

(Available from Jenkins Equipment Co.  
Dexter, Michigan 48130)



**REAR TAIL LIGHT KIT** **AP70**

- Double light, bright rear tail light
- Complete with all mounting hardware and wire
- Operates with headlights from the tractor light switch

## ELECTRIC TRACTOR FACTS

### PERFORMANCE

#### Mowing: (on one charge)

60-inch 3 gang reel mower 3 to 5 acres  
42-inch rotary mower\* 2.5 to 3.5 acres  
\*(At approximately one acre per hour)

#### Hauling/Lawn Sweeping:

300 lb. load in 2 wheel cart 5-6 hours @ 3-4 MPH

#### Snow Blowing: (0-30°F)

42-inch single stage  
Light snow (2-8 inches) up to 6-10 driveways  
Medium snow (9-17 inches) up to 3-5 driveways  
Heavy snow (18-24 inches) up to 2-3 driveways

#### Tilling:

Ground breaking and pulverizing:  
@ 4" depth 2 to 2.3 hrs. up to 20,000 sq. ft.  
@ 6" depth 1 to 1.2 hrs. up to 10,000 sq. ft.

#### Portable Power Tools:

Power drill, hedge trimmer, 15 to 20 hours  
lawn edger, cultivator  
Chain saw 4 to 6 hours

#### BUILT-IN BATTERY RECHARGE: (from standard 110V, 15 amp household outlet)

Complete recharge (95%) Approx. 5 hours\*  
75% recharge Approx. 3½ hours  
50% recharge Approx. 2 hours  
\*Charger runs longer for full battery equalization.

#### MODELS:

Model	Weight	Width & Length	Peak hp exceeds	Max. Speed
E 12	795	35"x69"	12 hp	6 mph
E 15	850	36"x69"	14 hp	7 mph
E 20	895	42"x69"	16 hp	9 mph

#### SPEED RANGE:

Variable speed from ¼ mph to speed with full automatic control.

#### ACCESSORIES:

A wide variety of standard tractor accessories is available. All Elec-Trak attachments can be installed in minutes, removed in seconds. In addition, many 36 volt tools are available which simply plug into the Elec-Trak tractor for instant power.

#### FEATURES:

- Single lever (E-12, E-15) or foot pedal (E-20) speed control for both forward and reverse.
- Driver seat safety interlock—removes power when driver leaves seat. No accidental restarting.
- Electrically braked mower blades stop within three seconds.
- Front mounted rear-discharge mower discharges underneath tractor, between wheels. Allows easier trimming under shrubs and easy blade resharpening.
- "Programmed" starting sequence reduces risk of rollover on hills if speed control lever or foot pedal suddenly pushed to maximum speed.
- Very low center of gravity.
- "Human engineered" driver seating, control accessibility.
- Full brake pressure disconnects electrical power.

#### WARRANTY: (residential use)

In addition to a one year guarantee against defects on all tractor parts, the Elec-Trak features a five year battery guarantee. The battery is guaranteed against defects for the first two years, with a pro rata charge during the last three years.

General Electric Company  
Outdoor Power Equipment Operation  
Corporations Park, Bldg. 702  
Schenectady, N. Y. 12305

GENERAL  ELECTRIC